

FOREST FMS PLUS RECESSED MOTORISED TRACK

- Smooth Belt driven Recessed motorised curtain track system
- Touch Impluse Technology, gently pulling the curtain by hand will activate the motor
- Integrated Emergency Control - In case of a power failure, the drapes can be moved manually
- Can be operated by Wall Switch, Remote Control or Time Switch
- Easy to connect to Building Automation System
- Clickable off-set carrier for a straight heading of the curtain
- Vanda Wave Heading available
- Ultra Silent Motor
- 10 Year Warranty

Forest Diamond remote Control
6 channel remote control, possibility to control up to 6 systems individually
and in group Radio control, range up to 30 meters

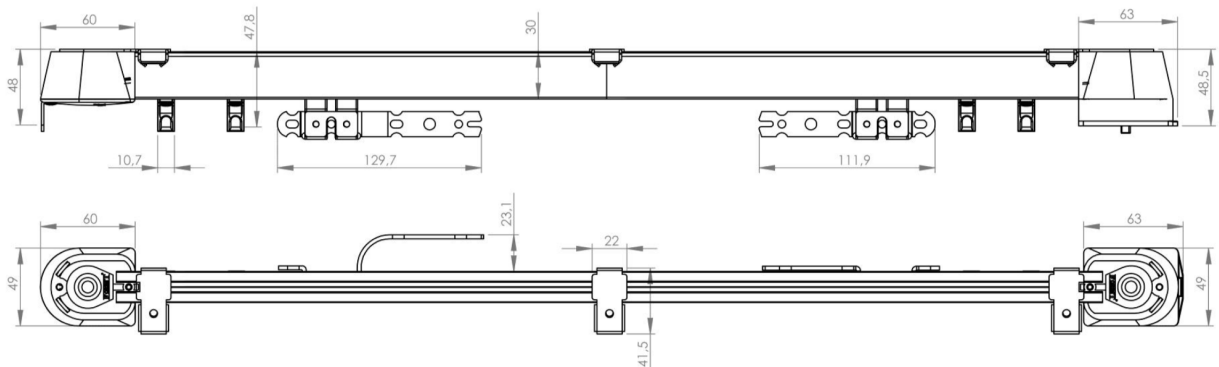

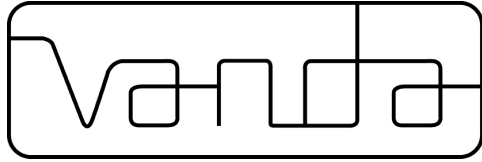

FOREST SHUTTLE MOTOR DIMENSIONS

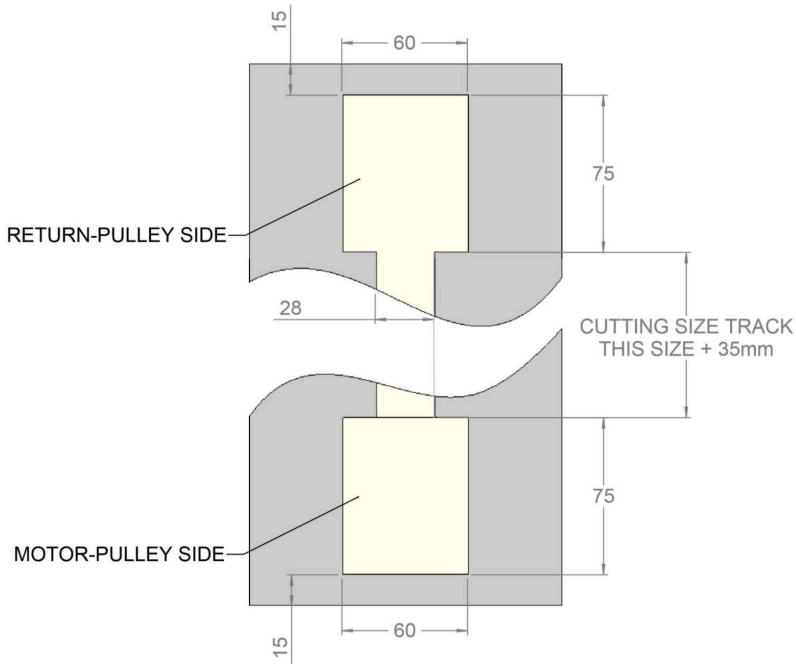
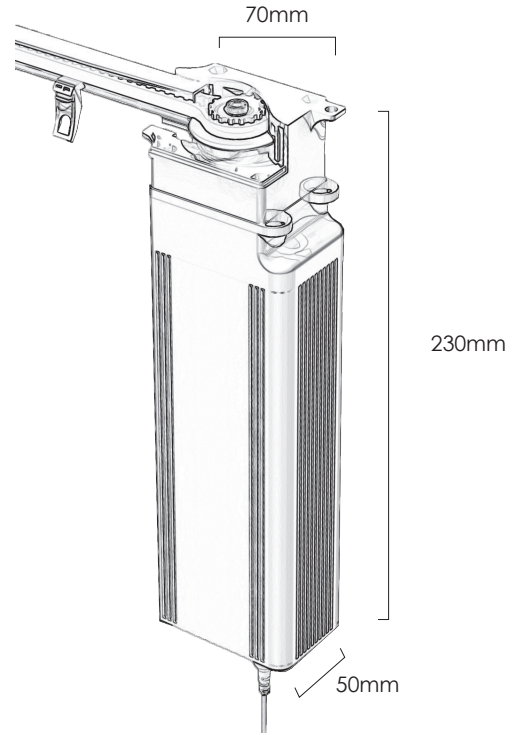
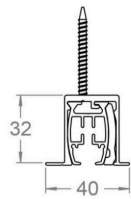
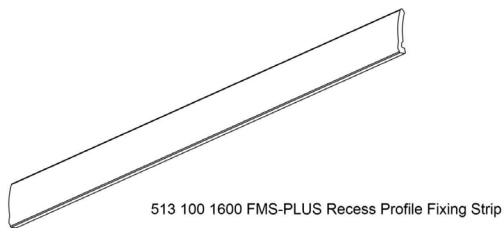
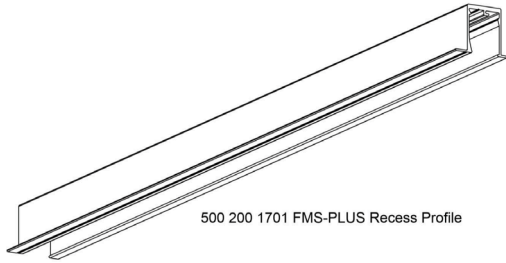

FMS TRACK - GLIDE/CARRIER

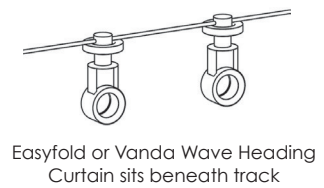
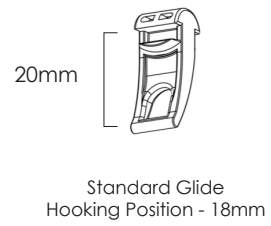

VANDA HOLDINGS LTD
 Auckland - Unit G, 166 Marua Road, Ellerslie, Auckland
 Christchurch - 43 Epsom Road, Sockburn, Christchurch
 P: 0800 826 326 F: 09 580 1351
 E: admin@vanda.co.nz
 www.vanda.co.nz